

Electrical drawing

IS-034 400V

Page title: Front Page

Project title: Baader IS-034 400V

Project no.: EL.IS-034.400V.R12

Filename: Baader IS-034 400V R12

Last correction: 2.5.2016

Constructor Guðbrandur

Designer Guðbrandur

Drawing Ingvar Á. Jochumsson

Page 1

Number of pages: 8



Baader IS-034 400V

1

2

Power wiring

3

Control circuit

4

Control circuit

5

Mechanical layout

6

Frequency converter
programming

7

8

9

10

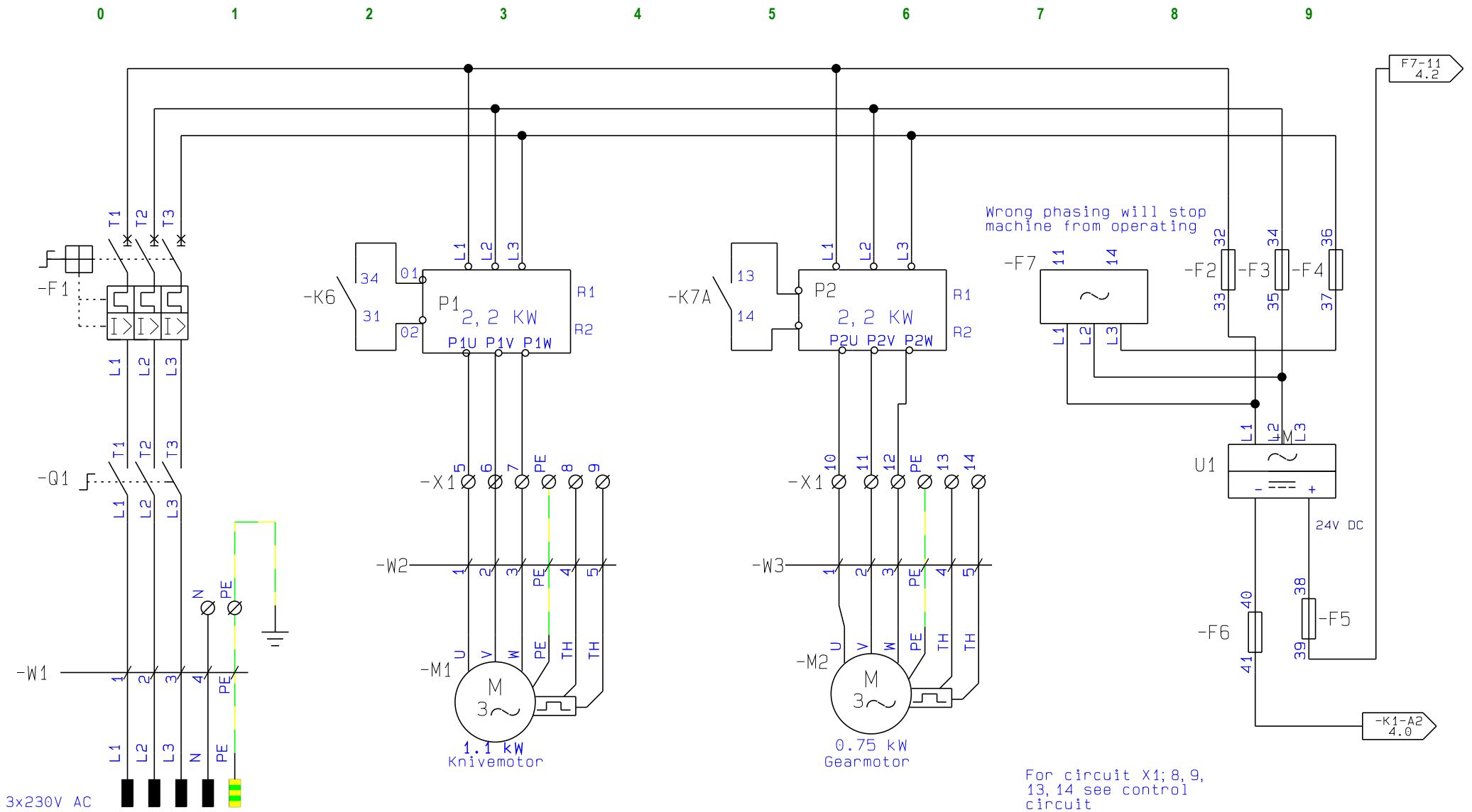

Project title:	Baader IS-034 400V	Project no.:	EL.IS-034.400V.R12	Page	3
Customer:	Baader Island ehf	Constructor	Guðbrandur	Number of pages:	8
Page title:	Power Wiring	Designer	Guðbrandur		
Filename:	Baader IS-034 400V R12	Drawing	Ingvar Á. Jochumsson		

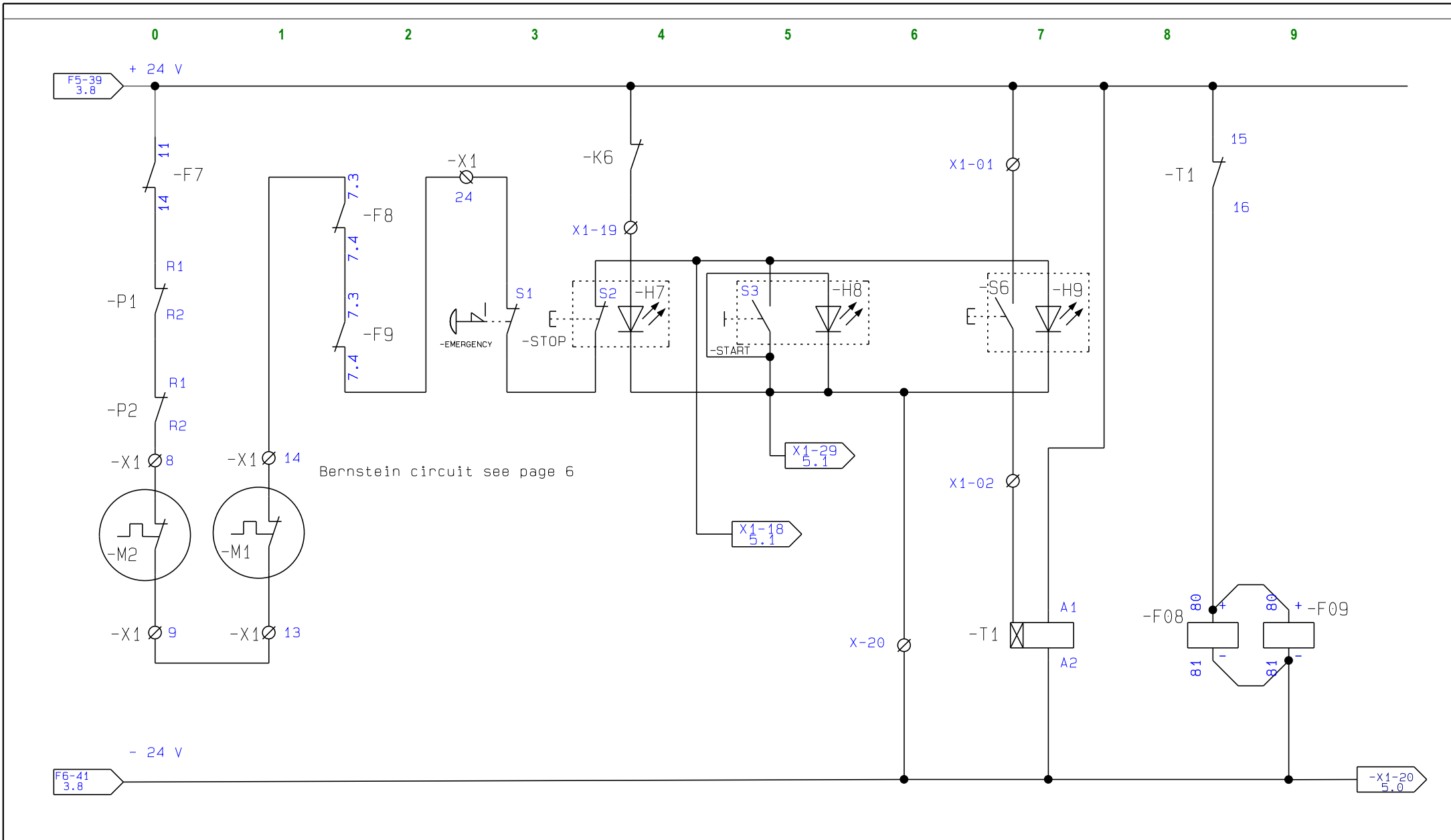

Project title:	Baader IS-034 400V	Project no.:	EL.IS-034.400V.R12	Page	4
Customer:	Baader Island ehf	Constructor	Guðbrandur	Number of pages:	8
Page title:	Control Circuit	Designer	Guðbrandur		
Filename:	Baader IS-034 400V R12	Drawing	Ingvar Á. Jochumsson		

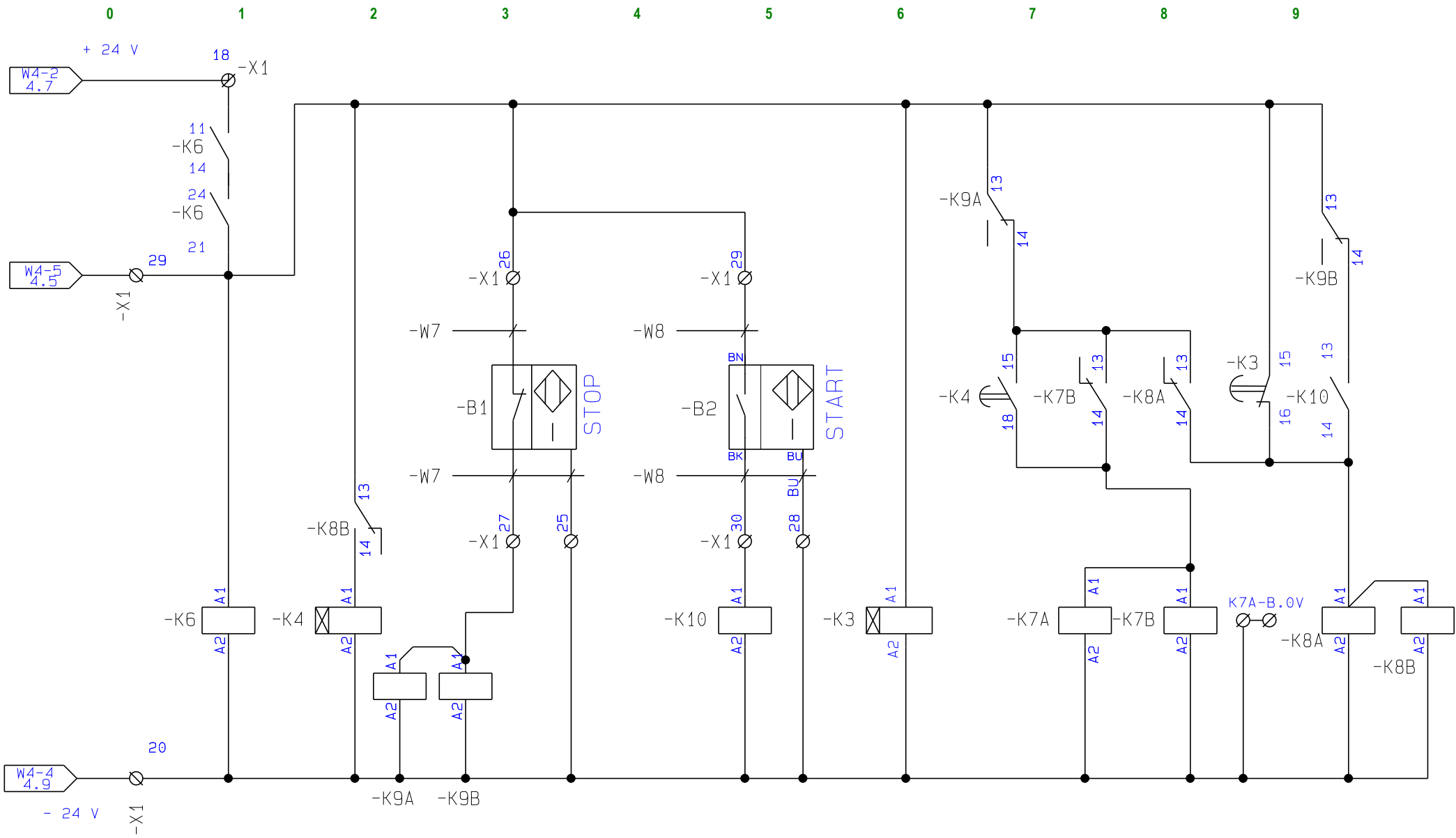

Project title:	Baader IS-034 400V	Project no.:	EL.IS-034.400V.R12	Page	5
Customer:	Baader Island ehf	Constructor	Guðbrandur	Number of pages:	8
Page title:	Control Circuit	Designer	Guðbrandur		
Filename:	Baader IS-034 400V R12	Drawing	Ingvar Á. Jochumsson		

Circuit included in control circuit page 4

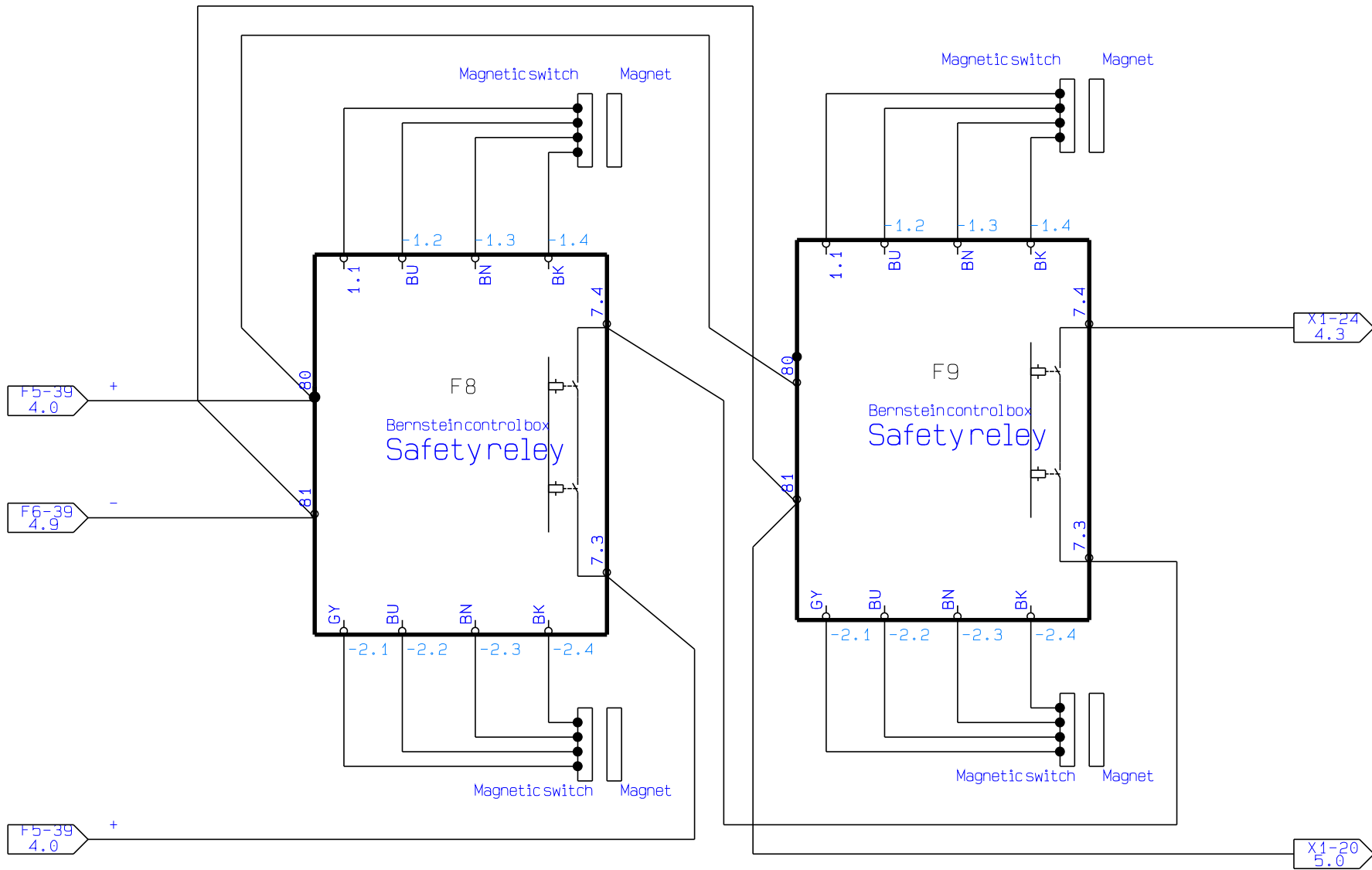

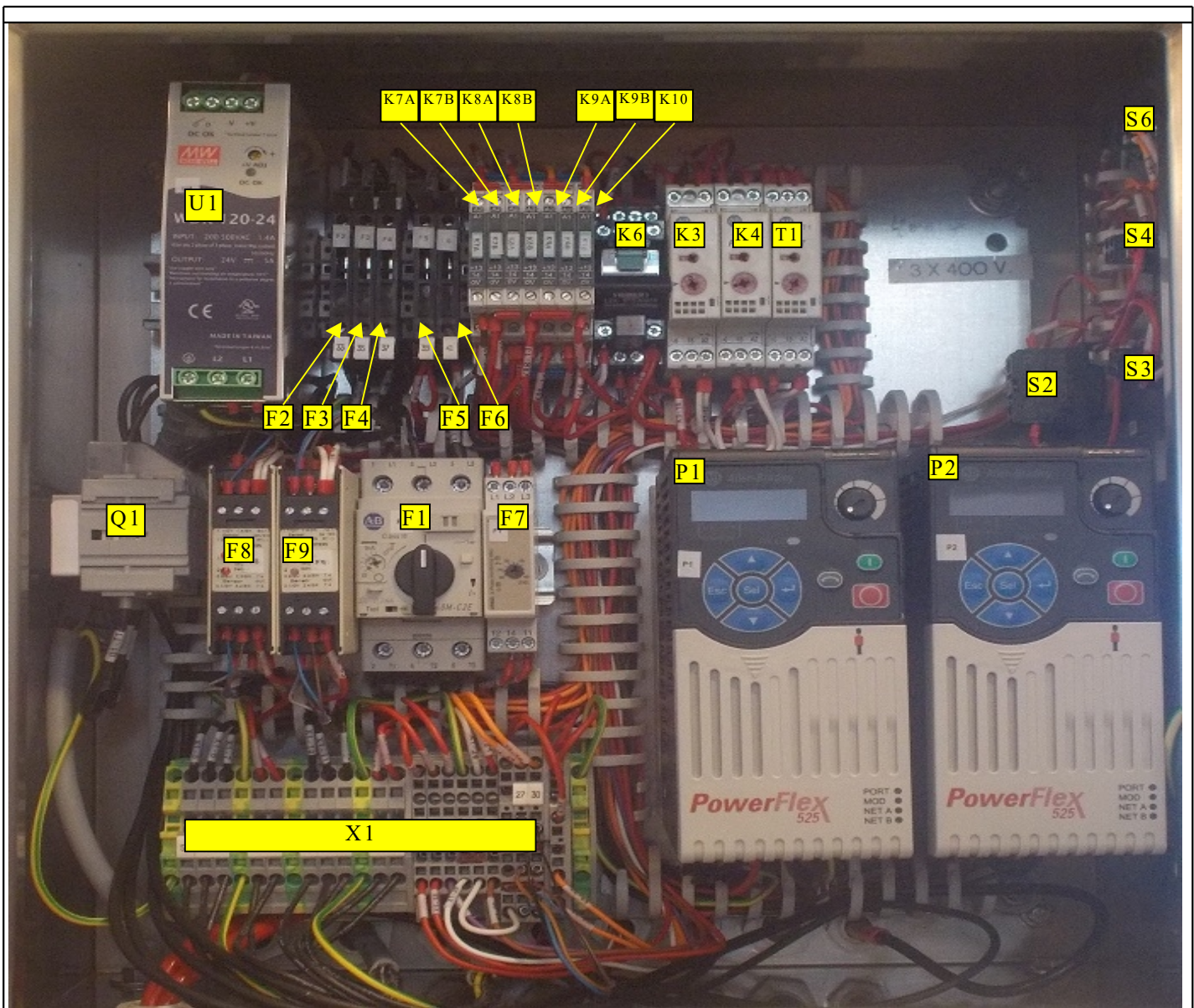

Name	Manufacturer	Spare part number	Description	Position
Motor Switch	AB	6064668	MS 132 - 16	F1
Power Supply	Mean Well	07-6065365	WDR-120-24	U1
Semi Contactor 24V DC	Siemens	6061831	Sirius 3RF34	K1
Phase Monitor	Carlo Gavazzi	DPA53CM48	DPA 53	F7
Fuse Holder	Phönix	3004100	UK5 - HESI	F2-F6
Fuse - 1 A	N/A	6115035	5x20 mm T 1A	F4 - F6
Fuse - 4 A	N/A	6115065	5x20 mm T 4A	F7 - F8
Connector	Phönix	3031953	STI - 4	X1
Frequency Converter	AB	6065664	2,2 KW 400 V.	P1
Frequency Converter	AB	6065664	2,2 KW 400 V.	P2
Time Delay	AB	6063040	FEA 3T	K3-K4
Time Delay	AB	6063040	FEA 3T	T1
Control Relay	Siemens	SALZS:PT5A5L24	LZS: PT5A5L24	K6
Control Relay	Siemens	SALZS:RT4A4L24	LZS: RT4A4L24	K9
Safety Relay	Bernstein	6392702307	6392702307	F8-F9
Semi Optocoupler Relay	Siemens	SATX7 004-3PB74	3TX7 00.-3PB54	K7A-K10
Push Button (White)	AB	6059605	800K-22FMW24X10	S6
Push Button (Green)	AB	6059610	800K-22FMG24X10	S4
Push Button (Red)	AB	6059600	800K-22FMR24X10	S3
Emergency Stop Button	AB	6059235	800FP-MT44PX01	S2

Page title: Mechanical layout (A4)	Project title: Baader IS-034 400V	
	Project no.: EL.IS-034.400V.R12	
 BAADER ÍSLAND ehf	Filename: Baader IS-034 400V R12	Page 7
	Last correction: 2.5.2016	Number of pages: 8
	Constructor: Guðbrandur	
	Designer: Guðbrandur	
	Drawing: Ingvar Á. Jochumsson	

Programming Allen-Bradley Frequency Converter for IS-034 400V Knife Motor

Parameters for IS-034 400V

Code	Parameter	Value
P031	Motor nominal voltage	400V
P032	Motor nominal Frequency	50 Hz
P033	Current limit	11 A
P034	Motor nominal current	7,3 A
P036	Motor nominal speed	1440
P041	Acceleration time	3
P042	Deceleration time	0,5
P043	Min frequency	50 Hz
P044	Max frequency	50 Hz
P045	Stop function	0
P046	Start function	2
P047	Remote control place 1 frequency reference selection	2

For other parameters refer to factory settings

Programming Allen-Bradley Frequency Converter for IS-034 400V Transportation Motor

Parameters for IS-034 400V

Code	Parameter	Value
P031	Motor nominal voltage	400V
P032	Motor nominal Frequency	50 Hz
P033	Current limit	11 A
P034	Motor nominal current	7,3 A
P036	Motor nominal speed	1440
P041	Acceleration time	0,8
P042	Deceleration time	0,2
P043	Min frequency	55 Hz
P044	Max frequency	55 Hz
P045	Stop function	0
P046	Start function	2
P047	Remote control place 1 frequency reference selection	2

For other parameters refer to factory settings